

# PFR-1750 LOAD CONTROL INSTALLATION, SET UP AND ADJUSTMENT

The Model PFR-1750 monitors the true power going to a motor. By sensing power (volts x amps x power factor) rather than just amps, there is much greater sensitivity. The unit has two adjustable trip points.

## MOUNTING

Wiring is done to un-pluggable terminal strips on the rear of the unit.

Three ways to mount:

- On door or raceway - use cutout template
- Panel Mount - use template + optional Bezel Kit (No Charge)
- On wall - on standard outdoor junction box + optional Outlet Box Adapter (No Charge)

## VOLTAGE

120 volts AC is taken from two of the phases. If the motor starter already has a 120-volt control transformer with 10VA of free capacity, it can be used. Otherwise, install a separate transformer. It is okay if the secondary is grounded.

**BE SURE TO NOTE WHICH TWO PHASES SUPPLY THE TRANSFORMER.**

In 120/208V three-phase system, the 120V MUST come from a transformer connected to two of the phases. The 120V phase to ground voltage cannot be used.

## CURRENT

The current signal is taken from the REMAINING phase.

This current sample passes through the Range Finder Toroid.

It is VERY IMPORTANT that the current signal comes from the phase that IS NOT supplying the 120V control transformer. Be extra careful when the machine has reversing starters or multi-speed windings. If a wrong phase is used the control will either:

- Work backwards
- Have reduced sensitivity

If you are using a variable frequency drive, use a different control.

Call LOAD CONTROLS, INC for help.



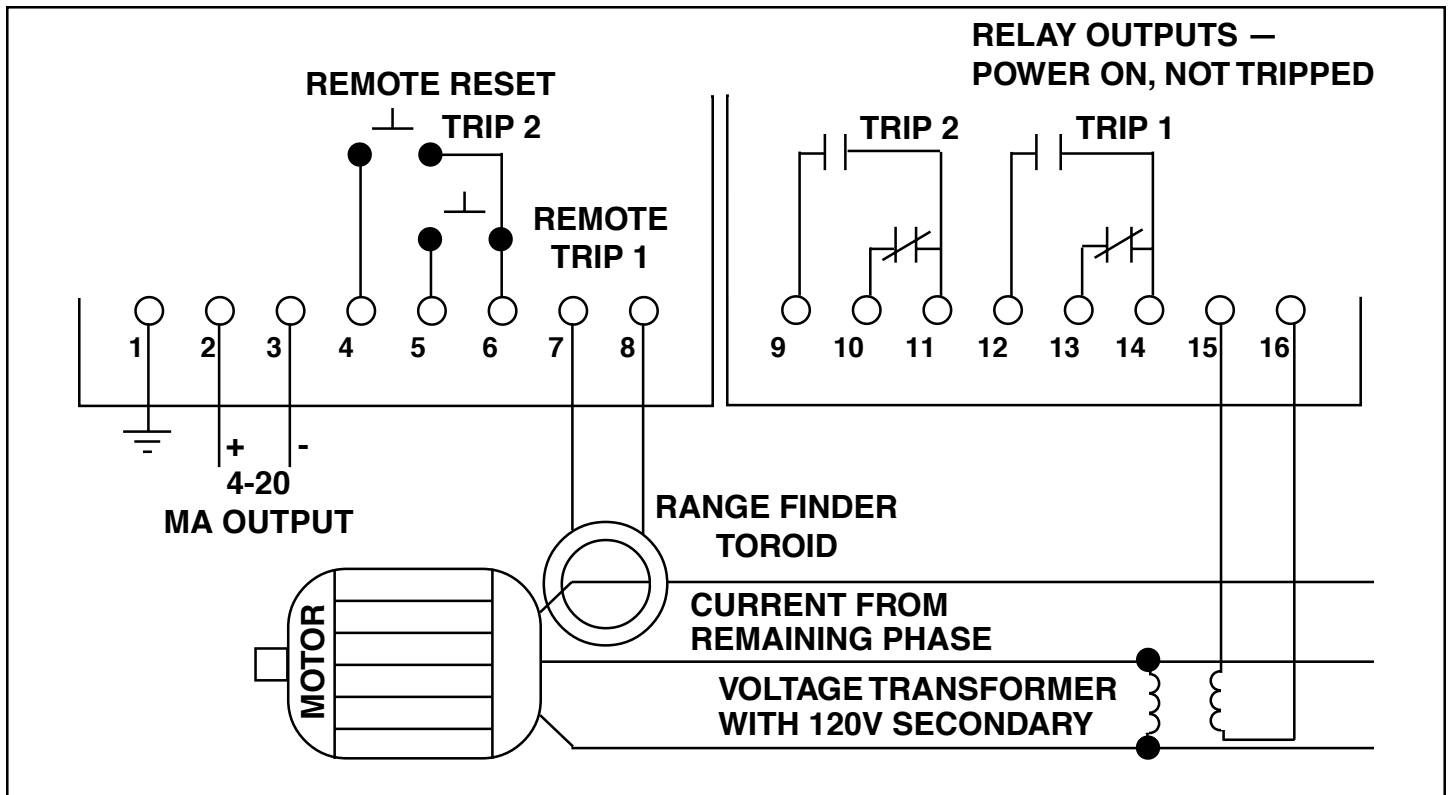

### FULL SCALE CAPACITY AT 460 VOLTS

The Range Finder Toroid has six motor size choices. Select one that is equal or larger than your motor. This will leave some headroom.

- For motors less than 5 HP (460 volt), take extra turns.
- For motors greater than 50 HP, use Range Finder Toroid + Current Transformer.

MOTOR SIZE	FULL SCALE CAPACITY	% FULL LOAD	RANGE FINDER SWITCH	TURNS	CURRENT TRANSFORMER
1/2 HP	.6 HP	123	2 ON	8	
1	1.25	123	2 ON	4	
1-1/2	1.65	109	2 ON	3	
2	2.70	134	2 ON	2	
3	3.80	128	3 ON	2	
5	5.50	110	2 ON	1	
7-1/2	8.25	110	3 ON	1	
10	11.0	110	4 ON	1	
15	27.5	183	5 ON	1	
20	27.5	137	5 ON	1	
25	27.5	110	5 ON	1	
30	55.0	183	6 ON	1	
40	55.0	138	6 ON	1	
50	55.0	110	6 ON	1	
60	84.0	140	1 ON	1	100:5
75	84.0	112	1 ON	1	100:5
100	130	130	1 ON	1	150:5
125	130	104	1 ON	1	150:5
150	173	115	1 ON	1	200:5
200	216	108	1 ON	1	250:5
250	260	104	1 ON	1	300:5
300	346	115	1 ON	1	400:5

### MULTIPLIERS

For nominal voltages other than 460 volts, multiply 460V full scale by:

$$208V = .45$$

$$230V = .5$$

$$380V = .83$$

$$415V = .9$$

$$575V = 1.25$$

For Kilowatts multiply Full Scale HP x .746

For motor sizes or capacities not in table:

$$\% \text{ Full Load} = \frac{\text{Full Scale Capacity}}{\text{Your Motor Size}} \times 100$$

# RANGE FINDER TOROID

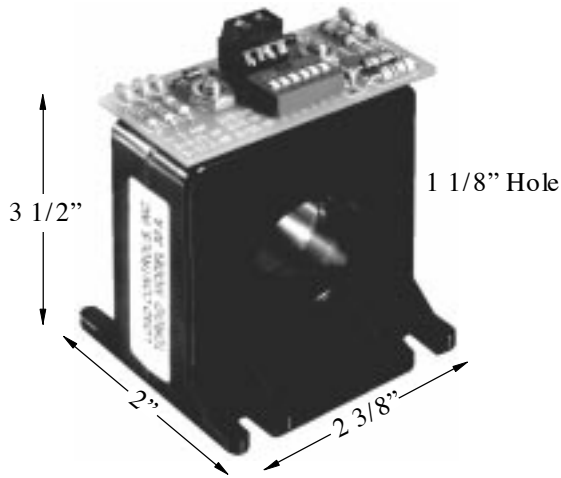

## FOR MOTORS LESS THAN 5 HP

Take more "turns" of the leg through the Toroid. Each time the wire passes through the Toroid is a "turn".

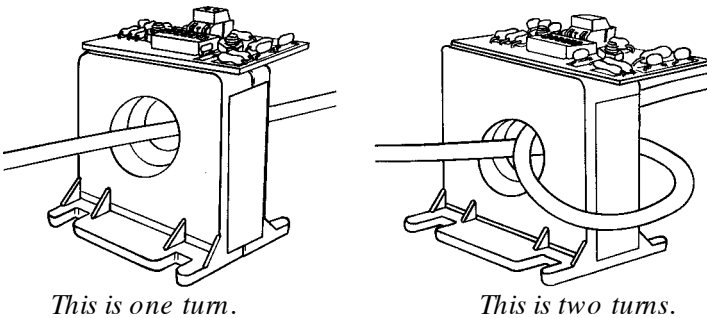

*This is one turn.*

*This is two turns.*

## FOR MOTORS GREATER THAN 50 HP

A Current Transformer is used to reduce the primary current. The 5-amp secondary passes through the Toroid.

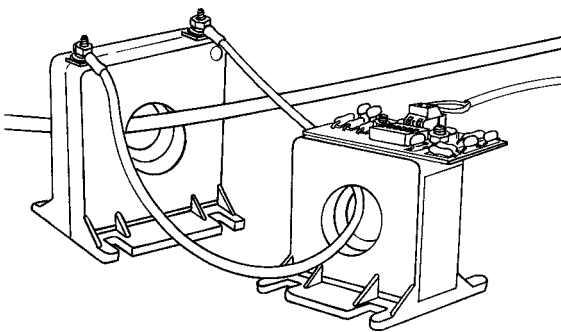

*Pass secondary of CT through toroid.*

## CAUTION

When current is flowing through the primary of the external current transformer, always have a wire between the two brass terminals on the CT.

If they are left open, dangerous and destructive voltages can develop.

## HOOKING UP THE RESET

Control can be reset three ways:

- Manually with the Reset button on the control.
- Remotely with a remotely located reset button or relay.
- Automatic with a jumper.

### Remote Reset-

Momentarily connect Terminal 4 to Terminal 6 for Trip 1.  
Momentarily connect Terminal 5 to Terminal 6 for Trip 2.

### Automatic Reset-

Jumper Terminal 4 or 5 to Terminal 6.

The terminals for Reset generate a small amount of current (8-12 milliamps). To reset, you just need to connect the terminal to the circuit common (Terminal 6).

The switches or relays that you use must be suitable for low current (Gold flashed contacts, Reed Relays, Mercury Switches).

## 4-20 MILLIAMP ANALOG OUTPUT

The Analog Output is directly proportional to Full Scale capacity. It is always active. 500 ohm maximum connected impedance.

Terminal 2	4-20mA	Positive
Terminal 3	4-20mA	Negative

Use twisted pair or in noisy environments use shielded cable. Ground shield at other end.

Use the Full Scale capacity from the chart to scale external meter, chart recorders or computers.

## THE PFR-1750 POWERS THE 4-20 MA SIGNAL DON'T USE AN EXTERNAL DC POWER SUPPLY!

### SPECIFICATIONS PFR-1750

#### ENCLOSURE

Glass-filled Polycarbonate  
NEMA 4, 4X - STYLE  
(3 1/4" x 6 1/4" x 2")  
(83 mm x 160 mm x 54 mm)

#### ANALOG OUTPUT

4-20mA; powered by the  
PFR-1750 500 OHM  
maximum connected  
impedance

#### CAPACITY

To 50 horsepower directly  
through Toroid  
To 500 horsepower with external  
Current Transformer & Toroid

#### RESPONSE TIME

25 Milliseconds

#### TEMPERATURE

0°C - 55°C

#### DIGITAL LOAD DISPLAY

4" LED 3 Digit



#### TIMERS

Start-up and Trip Delay(s)  
0-90 second  
0-2 second in .1 second  
increments  
2-90 second in 1 second  
increments





#### RELAY OUTPUTS

(2) Form C 3 AMP @ 300 VAC or  
1/8 HP @ 240 VAC  
Latch when tripped

## TO SET FULL SCALE

- After hook-up, find your HP, KW or % from the chart
- Decide if you want to display HP, % or KW
- The  cycles through the choices shown below and blinks slowly for each choice. Each press of  moves you to the next choice.

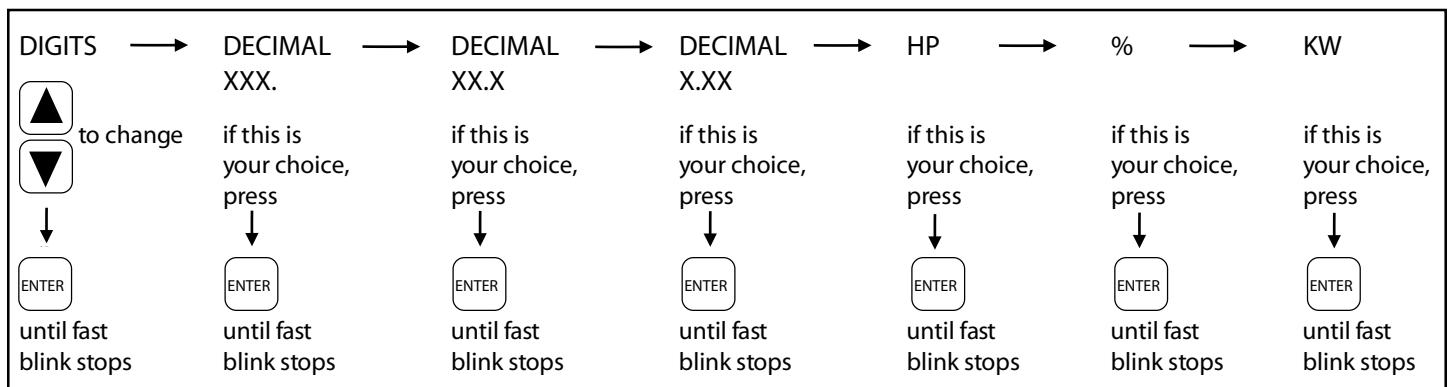

## FRONT PANEL SET-UP TIPS

- 1) None of the settings will be changed until you hold down  and the fast blinking stops.
- 2) Five seconds after you have pressed a button, the Control will return to normal operation.
- 3) If you hold down the   digits will continue to change.
- 4) You only need to do  when you install the Control (or if you change the hook-up).



## TO VIEW AND CHANGE THE SET POINTS AND DELAY TIMES

 cycles through the choices. The LED for each choice will turn ON.

To change a setting, use  

Press ENTER until quick blinking stops to store your new choice.

After 5 seconds if you haven't pressed any buttons, control will return to normal operation.

### Start-up Timer

The Start-up Timer bypasses the Control during motor start-up to avoid false trips because of current inrush. For convenience, the Start-up LED stays lit until the start-up period is over.

The start-up time should be:

- Long enough so that the load has stabilized

To bypass Start-up Timer set time to zero seconds

### Delay Timers

To avoid nuisance trips from short overloads, Delay Timers bypass the Control for the selected time. The relays won't trip until the time is exceeded. If the trip condition goes away before the time is up, the timer resets to zero.

- Start with minimum Delay. If you are getting trips where you don't want them, increase the Delay Time.