

PUMP LOAD CONTROL SYSTEM MODEL PMP-25V & UPC

The Pump Load Control System Model PMP-25V along with the Universal Power Cell Model UPC is used where the motor is being powered by an Electronic Variable Speed Drive. The UPC monitors the motor power and the 0-10 volt output from the UPC is used as the input to the PMP-25V.

MOUNTING

Wiring is done to un-pluggable terminal strips on the rear of the unit. Three ways to mount:

- On door or raceway - use cutout template
- Panel Mount - use template + optional Bezel Kit (\$10)
- On wall - on standard outdoor junction box + optional Outlet Box Adapter (\$10)

TERMINAL CONNECTIONS

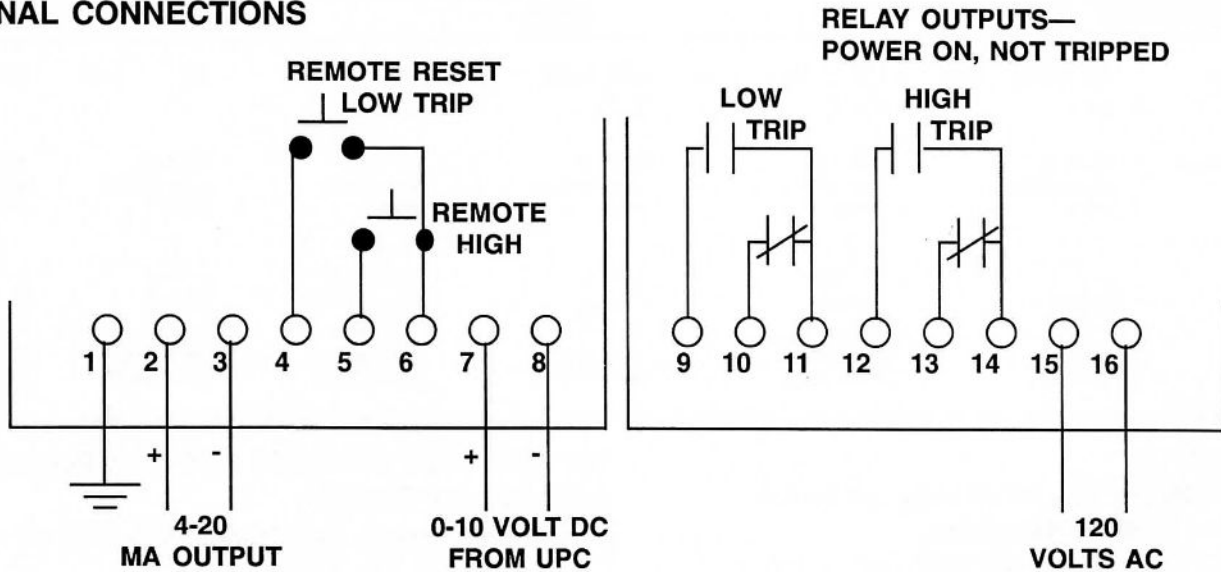

INSTALLING THE UNIVERSAL POWER CELL MODEL UPC

Install the UPC as shown on the 1 page UPC Data/Installation sheet.

Set the UPC Capacity to match your motor. The UPC measures power INPUT to the motor and pump curves are based on the OUTPUT of the motor. For simplicity, adjust the capacity of the UPC upward by the motor efficiency factor found on the motor nameplate.

EXAMPLE: 10HP motor .83 nameplate efficiency
Set input = 10HP/.83 = 12HP

HOOKING UP THE RESET

Control can be reset 3 ways:

- Manually with the Reset button on the control.
- Remotely with a remotely located reset button or relay.
- Automatic with a jumper.

Remote Reset -

Momentarily connect Terminal 4 to Terminal 6 for low
Momentarily connect Terminal 5 to Terminal 6 for high

Automatic Reset -

Jumper Terminal 4 or 5 to Terminal 6

The terminals for Reset generate a small amount of current (8-12 milliamps). To reset, you just need to connect the terminal to the circuit common (Terminal 6).

The switches or relays that you use must be suitable for low current. (Gold flashed contacts, Reed Relays, Mercury Switches).

**DON'T USE 10 AMP SWITCHES.
THEY WON'T BE RELIABLE.**

**DON'T PUT 120V ON TERMINALS 1-8.
IT WILL DESTROY THE CONTROL.**

4-20 MILLIAMP ANALOG OUTPUT

The Analog Output is directly proportional to Full Scale capacity. It is always active. 500 ohm maximum connected impedance.



Terminal 2	4-20mA	Positive
Terminal 3	4-20mA	Negative

Use twisted pair, or, in noisy environments, use shielded cable. Ground shield at other end.

Use the Full Scale capacity from the chart to scale external meter, chart recorders or computers.



FRONT PANEL SET-UP

TIPS:

- 1) None of the settings will be changed until you hold down  and the fast blinking stops.
- 2) 5 seconds after you have pressed a button, the control will return to normal operation.
- 3) If you hold down the  digits will continue to change.
- 4) You only need to do  when you install the PMP-25 (or if you change the hook-up).

TO SET FULL SCALE

The Full Scale Capacity of your system is the capacity you set for the UPC Power Cell. It is best to set a capacity greater than your motor size to give you headroom.

- To set %: $(\text{Capacity of UPC/Your Motor Size}) \times 100 = \text{Ratio}$ Enter this value. Display will read 100% when your motor reaches Full Load.
- To set HP or KW: Enter the capacity you set for the UPC.
- The  cycles through the choices shown below and blinks slowly for each choice. Each press of  moves you to the next choice.

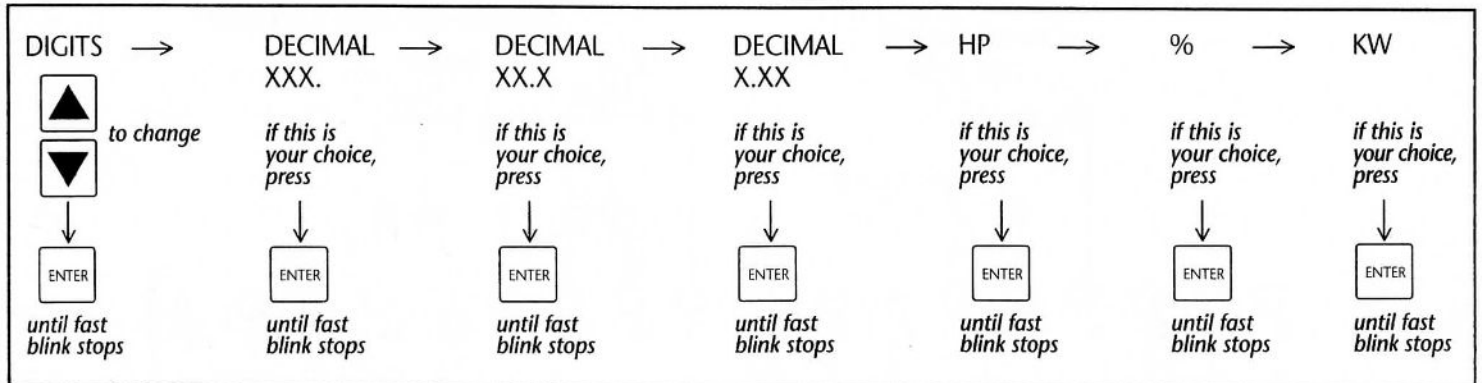

ADJUSTMENTS

SET POINT - HIGH: The HIGH relay will switch when the load is above the HIGH.

SET POINT - LOW: The LOW relay will switch when the load is below the LOW.

Start Up Timer

The Start Up Timer bypasses the Control during motor start up to avoid false trips because of current inrush. For convenience, the TIMING BEGINS WHEN THE MOTOR STARTS. The Start Up LED stays lit until the Start Up period is over.

The start up time should be:

- Long enough so that the load has stabilized.

Delay Timers

To avoid nuisance trips from short overloads, Delay Timers bypass the Control for the selected time. The relays won't trip until the time is exceeded. If the trip condition goes away before the time is up, the timer resets to zero.

- Start with minimum Delay. If you are getting trips where you don't want them, increase the Delay Time.

TO VIEW AND CHANGE THE SET POINTS AND DELAY TIMES

 cycles through the choices. The LED for each choice will turn ON.

To change a setting, use 

Press ENTER until quick blinking stops to store your new choice.

After 5 seconds if you haven't pressed any buttons, control will return to normal operation.

ADJUSTMENT TIPS FOR CENTRIFUGAL PUMPS From Pump Curves

Use recommended minimum and maximum flows and horsepower for your initial set points.

—OR—

Actual Operation

Low Trip - run the pump with the OUTLET valves closed. This is the minimum flow. Set the low trip about here.
High Trip - run the pump with all valves wide open. This is the maximum flow. Set the high trip about here.

- Make adjustments if you get nuisance trips.



TECHNOLOGY PARK
10 PICKER ROAD
STURBRIDGE, MA 01566

508-347-2606
FAX 508-347-2064